

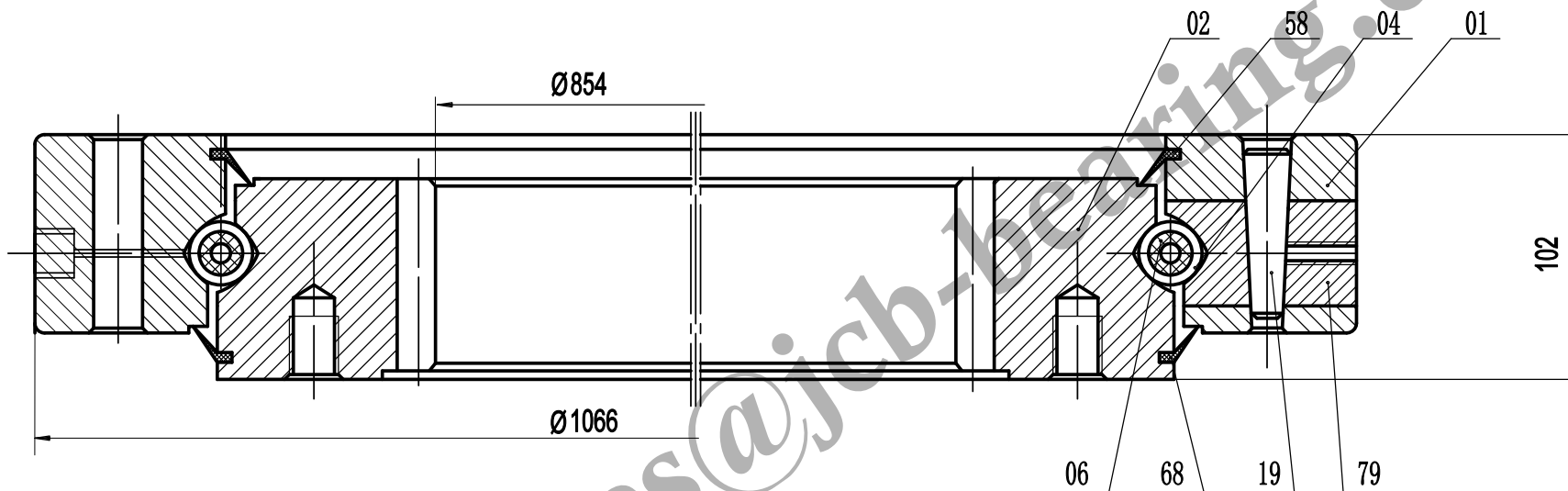

Module	m	10
Number of teeth	z	87
Addendum modification	x	0
Pressure angle	a	20°
Accuracy grade	10-ISO 1328/97	



Remark:

1. Luoyang JCB Bearing Technology Co., Ltd is a technical Inc, specialize in designing and manufacturin slewing ring bearing, we can design and manufactur all kinds of slewing bearing according to client's requirement.

2. This drawing is reference for user, if you need formal drawing, please contact wth us sales@jcb-bearing.com, the official drawing will be submitted after order confirmation.

Contact information

Company Address : No. 285, Fenghua road, Luoyang, Henan, China.

Postal code : 471000

Phone : 86-379-68611678 Fax : 86-379-68611679

E-mail: sales@jcb-bearing.com

Reserved E-mail: sales@slewing-ring-bearings.com

Website: www.jcb-bearing.com

www.slewing-ring-bearings.com

Single row ball slewing bearings	VI. 10. 0978 TN F81	
	Weight(kg)	
	178	
Luoyang JCB Bearing Technology Co., Ltd		