

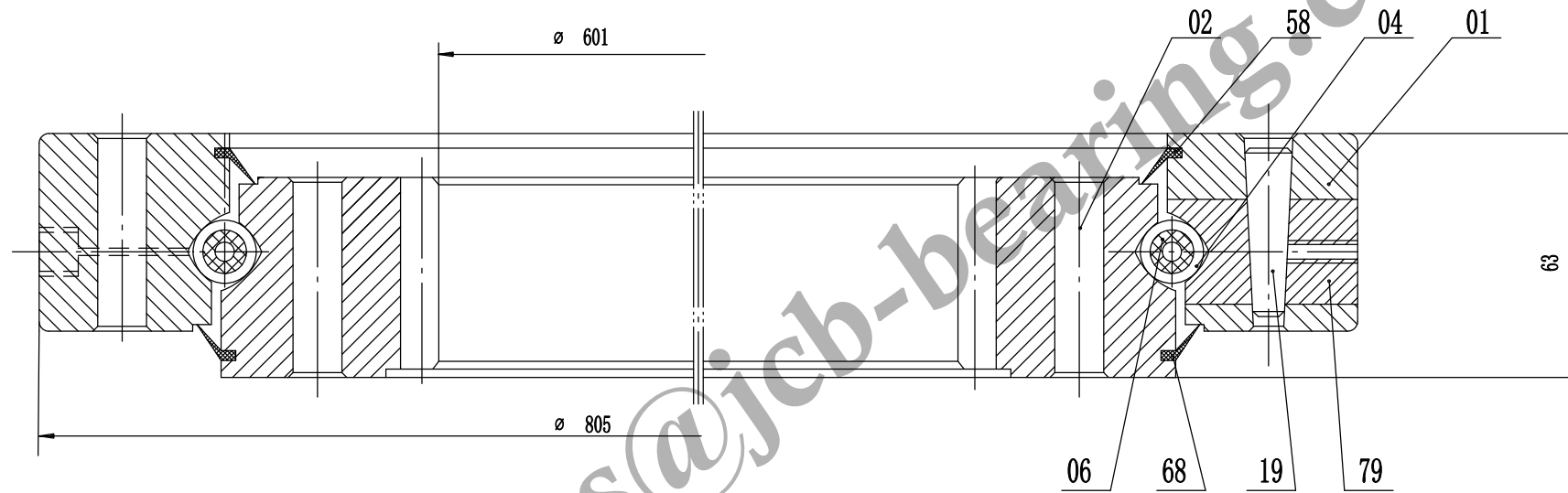

Module	m	6
Number of teeth	Z	102
Addendum modification	x	0
Pressure angle	a	20°
Accuracy grade	10-ISO 1328/97	



**Remark:**

1. Luoyang JCB Bearing Technology Co., Ltd is a technical Inc, specialize in designing and manufacturing slewing ring bearing, we can design and manufactur all kinds of slewing bearing according to client's requirement.
2. This drawing is reference for user,if you need formal drawing,please contact wth us sales@jcb-bearing.com, the official drawing will be submitted after order confirmation.

**Contact information**

Company Address : No. 285, Fenghua road, Luoyang, Henan, China.  
 Postal code : 471000  
 Phone : 86-379-68611678 Fax : 86-379-68611679  
 E-mail: sales@jcb-bearing.com  
 Reserved E-mail: sales@slewing-ring-bearings.com  
 Website: www.jcb-bearing.com  
 www.slewing-ring-bearings.com

Four-point contact ball Slewing Ring Bearing	601DBS106y		
			weight(kg)
			78
	Luoyang JCB Bearing Technology Co., Ltd		