

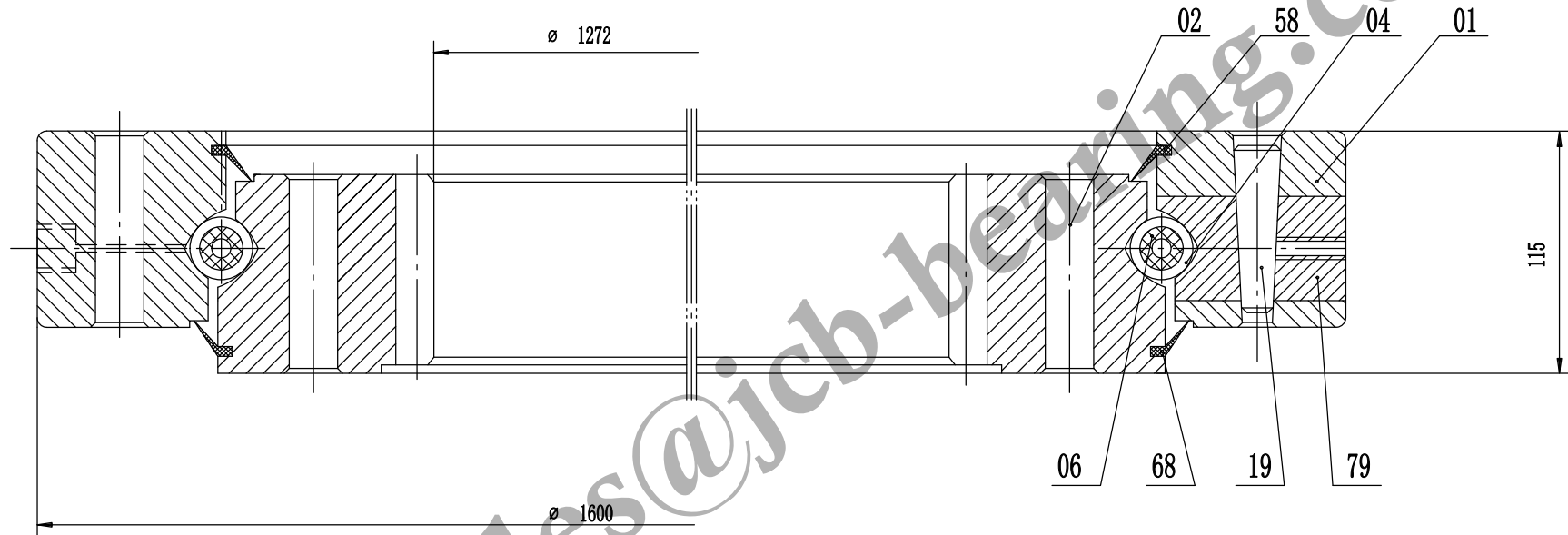

Module	m	12
Number of teeth	Z	108
Addendum modification	x	0
Pressure angle	a	20°
Accuracy grade		10-ISO 1328/97



Remark:

1. Luoyang JCB Bearing Technology Co., Ltd is a technical Inc, specialize in designing and manufacturing slewing ring bearing, we can design and manufactur all kinds of slewing bearing according to client's requirement.
2. This drawing is reference for user,if you need formal drawing,please contact wth us sales@jcb-bearing.com, the official drawing will be submitted after order confirmation.

Contact information

Company Address : No. 285, Fenghua road, Luoyang, Henan, China.
 Postal code : 471000
 Phone : 86-379-68611678 Fax : 86-379-68611679
 E-mail: sales@jcb-bearing.com
 Reserved E-mail: sales@slewing-ring-bearings.com
 Website: www.jcb-bearing.com
 www.slewing-ring-bearings.com

Four-point contact ball Slewing Ring Bearing	1272DBS102y		
		weight(kg)	
		490	
	Luoyang JCB Bearing Technology Co., Ltd		